

Varenummer: 03554040

Beskrivelse: Fluro hydraulik ledhoved FMA 40D

## Mål

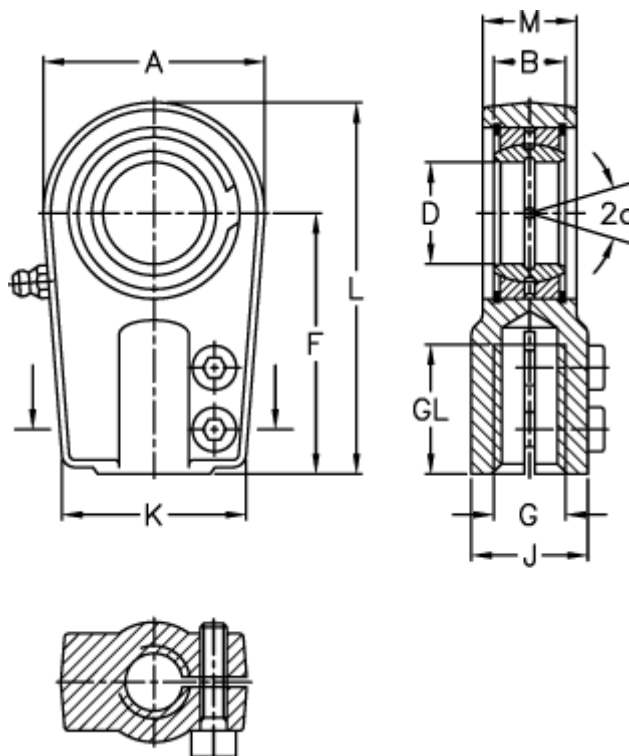

A	= 94	J	= 55
a (grader)	= 7	K	= 78
B	= 28	L	= 155
D	= 40	M	= 35
Dynamisk belastning C (kN)	= 140	Moment (Nm)	= 80
F	= 105	Statisk belastning C0 (kN)	= 297
g	= M39x3	Vægt	= 2400
GL	= 55		